

mestic®

Rooftop air conditioner RTA-2600



Baby it's
COOL
INSIDE

8870
BTU/h (1160 W)

53 dB

Mode

4 speeds

35 kg



User instructions **EN**

SMART ADVENTURE

A few words about your new air conditioning unit	8
Electrical data	8
Electric diagram	9
Packing list	10
Parts name	11
Operation of wireless remote controller	12
Control panel	17
Installation instruction	18
Step 1 - sticking the sealing strip and sponge pieces on the outdoor unit	18
Step 2 - selecting an installation location & installing the roof top air conditioner	19
Step 3 - mounting outdoor unit	22
Step 4 - installing the ceiling assembly	23
Step 5 - electrical wiring	25
Step 6 - completing the installation	27
Troubleshooting guide	28
Error code	29
Normal maintenance procedures	30

WARNING:

- This appliance is not intended for use by persons (including children) with reduced physical, sensory or mental capabilities, or lack of experience and knowledge, unless they have been given supervision or instruction concerning use of the appliance by a person responsible for their safety. Children should be supervised to ensure that they do not play with the appliance.
- This appliance can be used by children aged from 8 years and above and persons with reduced physical, sensory or mental capabilities or lack of experience and knowledge if they have been given supervision or instruction concerning use of the appliance in a safe way and understand the hazards involved.
- Children shall not play with the appliance.
- Cleaning and user maintenance shall not be done by children without supervision.
- When the refrigerant leaks or requires discharge during installation, maintenance, or disassembly, it should be handled by certified professionals and/or in compliance with local laws and regulations.

INSTALLATION PRECAUTION

WARNING:

- Observe all governing codes and ordinances.
- Do not use damaged or non-standard power cord.
- Be caution during installation and maintenance. Prohibit incorrect operation to prevent electric shock, casualty and other accidents.
- Before turning on the unit, please open the horizontal louver of indoor unit by hand, Otherwise, the cool air can't be blown out and there will be condensate water on the horizontal louver.
- The appliance contains the flammable gas R32.
- Be aware that refrigerants may be odorless.
- The appliance shall be installed, operated and stored in a room with a floor area larger than 4 m².
- The appliance shall be stored in a room without continuously operating ignition sources. (For example: open flames, an operating gas appliance or an operating electric heater.)
- The appliance shall be stored in such a way as to prevent mechanical damage from occurring.
- Keep any ventilation openings clear of obstruction.
- Do not use means to accelerate the defrosting process or to clean, other than those recommended by the manufacturer.
- Should repair be necessary, contact your nearest authorized service centre. Any repairs carried out by unqualified personnel may cause dangerous situations.

Working temperature range

Suggested working temperature range: -5 ~ 46°C . (heating:-5~24°C/cooling:+18~46 °C). The outdoor unit may stop operating, due to various kinds of protection within the working temperature range.

Selection of Installation Location

Basic requirement

Installing the unit in the following places may cause malfunction. If it is unavoidable, please consult the local dealer:

1. The place with strong heat sources, vapors, flammable or explosive gas, or volatile objects spread in the air.
 2. The place with high-frequency devices (such as welding machine, medical equipment).
 3. The place near coast area.
 4. The place with oil or fumes in the air.
 5. The place with sulfureted gas.
 6. Any other place with special circumstances.
-
7. This air conditioner unit is only used for the vehicle without concave and convex surface on the top of it.
 8. Prohibit operating this air conditioner unit when starting up the vehicle or when the vehicle is driving.
 9. Prohibit supplying the power for the air conditioner unit with the vehicle power supply.

Requirement of air conditioner

1. Air inlet should be far away from obstacles and do not put any objects near air outlet. Otherwise, it will affect the radiation of heat-removal pipe.
2. Select a location where the noise and outflow air emitted by the outdoor unit will not affect neighborhood.
3. Please try your best to keep far away from fluorescent lamp.
4. The appliance shall not be installed in the laundry.

INSTALLATION PRECAUTION

Requirements Forelectric Connection

Safety precaution

1. Must follow the electric safety regulations when installing the unit.
2. According to the local safety regulations, use qualified power supply circuit.
3. For appliances with type Y attachment,the instructions shall contain the substance of the following.If the supply cord is damaged,it must be replaced by the manufacturer, its service agent or similarly qualified persons in order to avoid a hazard.
4. Properly connect the live wire, neutral wire and grounding wire of power socket.
5. Be sure to cut off the power supply before proceeding any work related to electricity and safety.
6. Do not put through the power before finishing installation.
7. the air conditioner is first class electric appliance. It must be properly grounding. With specialized grounding device by a professional. Please make sure it is
8. The yellow-green wire or green wire in air conditioner is grounding wire, which can't be used for other purposes.
9. The grounding resistance should comply with national electric safety regulations.
10. The appliance shall be installed in accordance with national wiring regulations.

A FEW WORDS ABOUT YOUR NEW AIR CONDITIONING UNIT

Thank you for choosing the Recreational Vehicle Air Conditioner. This manual will supply you with all the information for installation, operation and maintenance. Take a few minutes to discover how to get the most in cooling comfort and economic operation from your new air conditioner. Please keep this manual well for future reference. An all-pole disconnection switch having a contact separation of at least 3mm in all poles should be connected in fixed wiring. As well as an circuit breaker with the capacity of 10A. The circuit breaker should include a magnetic and thermal release function, so it can protect against short-circuiting and overloading.







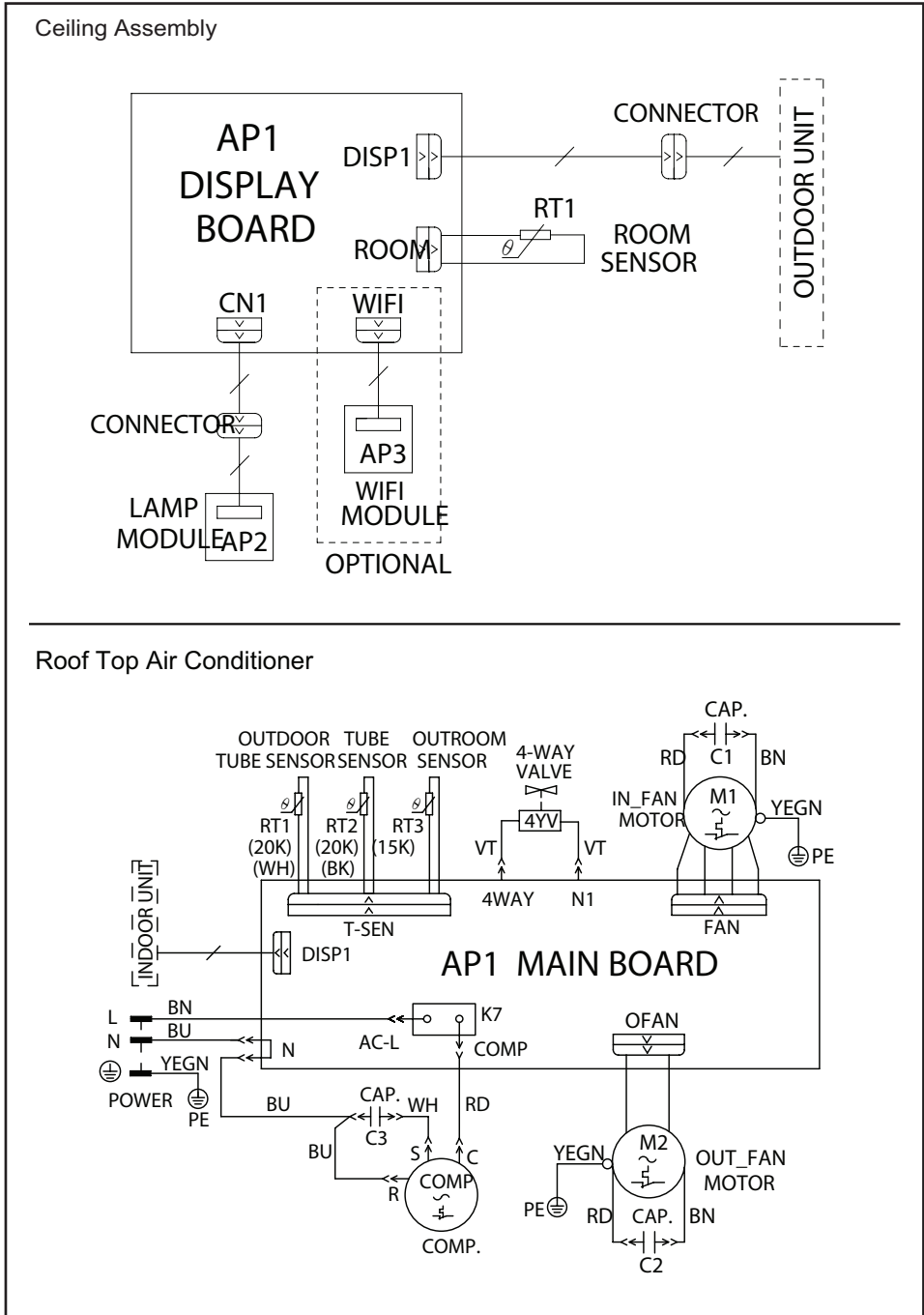



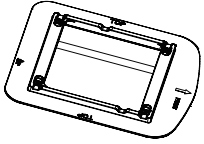

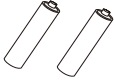
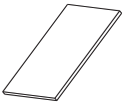
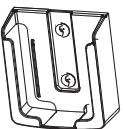
ELECTRICAL DATA

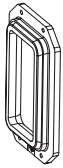
1. All wiring must be complied with local and national electrical codes. All wiring must be installed by qualified electricians. If you have any questions about the following instructions, contact a qualified electrician.
2. Check the available power supply and resolve any wiring problems BEFORE installing and operating this unit.
3. This air conditioner is designed to operate from a 220-240V AC, 50Hz, 1 Phase power supply.
4. The wiring diagrams are located on the cover of the control box. The assembly unit wire diagrams are located on the ceiling panel.
5. If the supply cord is damaged, it must be replaced by the manufacturer, its service agent or similarly qualified persons in order to avoid a hazard.
6. The Electric schematic diagram are subject to change without notice. Please refer to which one on the unit.

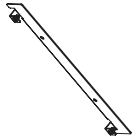
ELECTRIC DIAGRAM

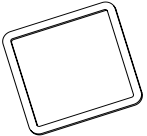

PACKING LIST

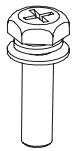
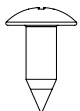
			
1	2	3	4
			
5	6	7	8
			
9	10	11	12
			
13	14	15	16
			
17	18		

- | | | |
|--|-----------------------------|-------------------------|
| 1. Owner's manual | 8. Foam (up) | 16. Bundle |
| 2. Mounting plate | 9. Foam (accessory) | 17. Bolt sub-assy M6X25 |
| 3. Remote controller | 10. Sponge (foam accessory) | 18. Tapping screw |
| 4. Battery (AAA 1.5V) | 11. Mounting plate sub-assy | |
| 5. Double-sided gummed paper | 12. Bolt sub-assy M8X135 | |
| 6. Remote controller holder | 13. Sponge (sealing strip) | |
| 7. Sunk screw (remote controller holder) | 14. Sponge | |
| | 15. Insulating sheath | |

PARTS NAME

Indoor Unit

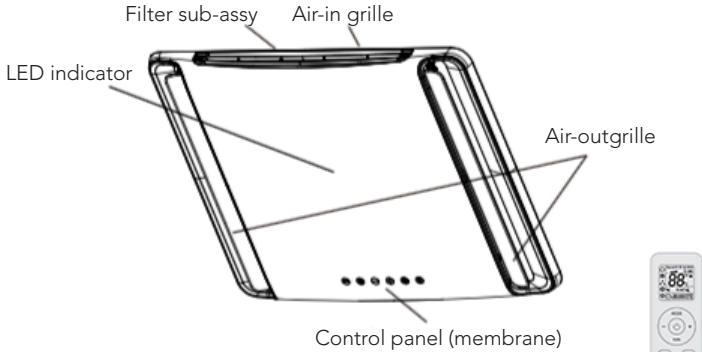

Remote controller

(Display content or position may be different from above graphics, please refer to actual products)

Outdoor Unit

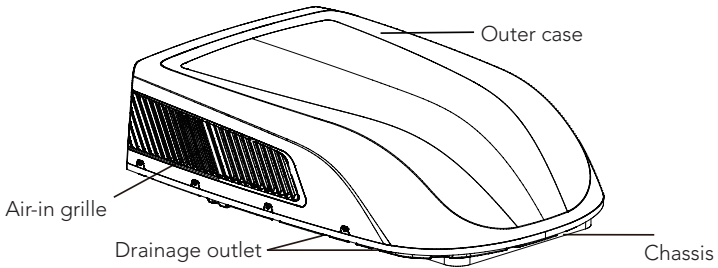

Notice:

Actual products may be different from above graphics, please refer to actual products.

OPERATION OF WIRELESS REMOTE CONTROLLER

Buttons

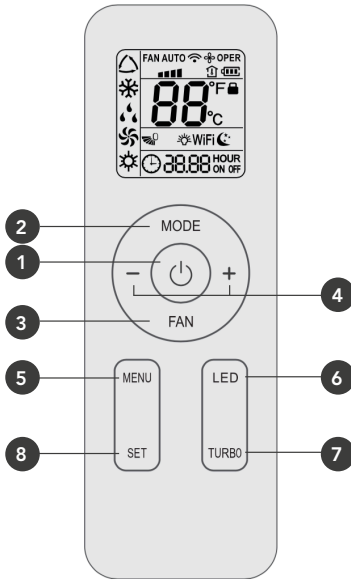

1. ON/OFF button
2. Mode button
3. Fan button
4. - / + button
5. Menu button
6. LED button
7. Turbo button
8. SET button

Icons on display screen

	FAN AUTO 	Set fan speed
		Send signal
Operation mode		Auto mode
		Cool mode
		Dry mode
		Fan mode
		Heat mode
		Sleep mode
		Light
		X-FAN function
		Indoor ambient temp.
		Clock
		Set temperature
	WIFI	WIFI function
		Set time
	ONOFF	TIMER ON/ TIMER OFF
		Up & down swing
		Child lock

INTRODUCTION FOR BUTTONS ON REMOTE CONTROLLER

Note:

- This is a universal remote controller, it can be used for multifunctional air conditioners. If an air conditioner model does not have a specific function, and the corresponding button is pressed, the unit will continue running in its original status.
- After turning on the power, the air conditioner will give out a sound and the operation indicator "⏻" is on. Now, you can operate the air conditioner through the remote controller.
- When the power is on, every time a button is pressed on the remote controller, the signal icon "📶" on the remote controller will flash once. The air conditioner will give out a sound, which indicates the signal has been sent to the air conditioner.

1. On/off button

- Press this button to turn the air conditioner on. Press this button again to turn the air conditioner off.

2. Mode button

- Press this button to select your required operation mode.

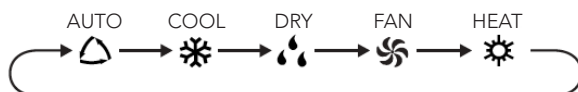

- In "AUTO" mode, the air conditioner will automatically operate according to the ambient temperature. The set temperature cannot be changed and will not be displayed. By pressing the "FAN" button, the fan speed can be adjusted.
- In "COOL" mode, press the "+" or "-" button to change the set temperature. To adjust the fan speed, press the "FAN" button.
- In "DRY" mode, the air conditioner operates at low speed. The fan speed cannot be adjusted.
- In "FAN" mode, only the fan is turned on, without any cooling or heating. Press the "FAN" button, to adjust the fan speed.
- In "HEAT" mode, press the "+" or "-" button to change the set temperature. To adjust the fan speed, press the "FAN" button.

Note:

- After the "HEAT" mode is selected, the air conditioner will delay air blowing 1-5 minutes, to prevent blowing cold air. (The actual delay time depends on the indoor ambient temperature.)
- The temperature can be set between 16-30°C (61-86°F).

3. Fan button

- This button is used for setting the fan speed in the following sequence:

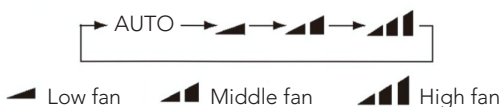

Note:

- In "AUTO" speed mode, the air conditioner will automatically select the proper fan speed according to the default setting.
- In "DRY" mode, the fan speed is low.
- "X-FAN" function: when the "FAN" button is pressed for 2 seconds in "COOL" or "DRY" mode, the icon "⊗" is displayed and the indoor fan will continue operation for a few minutes in order to dry the indoor unit, even when the unit is turned off. If the "FAN" button is now pressed for 2 seconds, the fan will stop immediately. "X-FAN" is not available in auto, fan or heat mode.

4. - / + button

- Press the “+” or “-” button once to increase or decrease the set temperature by 1°C(°F). Hold the “+” or “-” button down for at least 2 seconds, and the set temperature will change quickly. Once the “+” or “-” button is released after setting the temperature, the temperature indicator on the air conditioner will change accordingly. The temperature cannot be adjusted in “AUTO” mode.
- When setting the “TIMER ON” or the “TIMER OFF” or the “CLOCK”, press the “+” or “-” button to adjust the time. Look for more information under ‘Timer on function’, ‘Timer off function’, or ‘Clock function’.



5. Menu button

- Press this button to select the desired submenu and press the “SET” button to set the function status of the submenu. The submenu can be selected circularly as follows:



-  Light function
When the light function is selected, the light icon  flashes for 5 seconds. Press the “SET” button within 5 seconds to turn off the display light on the indoor unit. The  icon on the remote controller will disappear as well. Press the “SET” button again within 5 seconds to turn on the display light and the  icon will be displayed.
-  Sleep function
When the sleep function is selected, the sleep icon  flashes for 5 seconds. Press the “SET” button within 5 seconds to turn on the sleep function and the icon  will be displayed on the remote controller. Press the “SET” button again within 5 seconds to turn off the sleep function and the icon  will disappear.
-  Air outlet grille swing function
Not available for this model.
-  Ambient temperature display function
When the ambient temperature display function icon  flashes for 5 seconds, press the “SET” button within 5 seconds to select the ambient temperature display to be on or off. After setting the ambient temperature display on, the  icon will be displayed on the remote controller and the ambient temperature will be displayed on the indoor unit for a few seconds.
- “TIMER ON” function
With the “TIMER ON” function, the time for “TIMER ON” can be set. When the “TIMER ON” function is active, the  icon disappears and the word “ON” flashes on the remote controller. Press the “+” or “-” button to adjust the “TIMER ON” setting. By pressing the button “+” or “-”, the setting will increase or decrease with 1 minute at a time. Hold the “+” or “-” button for 2 seconds, the time setting will now change quickly until the required time is reached. Press the “SET” button within 5 seconds to confirm the new setting. The word “ON” will stop flashing.
To cancel “TIMER ON”: when the “TIMER ON” function has been selected and the word “ON” flashes on the remote controller, press the “SET” button until the word “ON” disappears.
- “TIMER OFF” function
With the “TIMER OFF” function, the time for “TIMER OFF” can be set. When the “TIMER OFF” function is active, the  icon disappears and the word “OFF” flashes on the remote controller. Press the “+” or “-” button to adjust the “TIMER OFF” setting. By pressing the button “+” or “-”, the setting will increase or decrease with 1 minute at a time. Hold the “+” or “-” button for 2 seconds, the time setting will now change quickly until the required time is reached. Press the “SET” button within 5 seconds to confirm the new setting. The word “OFF” will stop flashing.
To cancel “TIMER OFF”: when the “TIMER OFF” function has been selected and the word “OFF” flashes on the remote controller, press the “SET” button until the word “OFF” disappears.

-  Clock function

With the clock function, the clock time can be set. When the clock function is active, the  icon flashes on the remote controller. Press the “+” or “-” button within 5 seconds to set the clock time. By pressing the button “+” or “-”, the setting will increase or decrease with 1 minute at a time. Hold the “+” or “-” button for 2 seconds, the time setting will now change quickly until the required time is reached. Press the “SET” button within 5 seconds to confirm the new setting. The  icon will stop flashing.

6. LED button



- Press this button to turn the LED light on the panel on or off.

7. Turbo button

- In “COOL” or “HEAT” mode, press the “TURBO” button to turn on the quick “COOL” or “HEAT” mode. The  icon is now displayed on the remote controller. When this function is active, the air conditioner will run at a super-high fan speed, to quickly cool or heat. This way the ambient temperature approaches the pre-set temperature as soon as possible.

COMBINATION BUTTONS

Child lock function

- Press the "+" and "-" button simultaneously to turn on or to turn off the child lock function. When the child lock function is on, the  icon is displayed on the remote controller. If the remote controller is now used, the  icon will flash three times without sending a signal to the air conditioner.

Temperature display switch function

- When in "OFF" status, press the "-" and "MODE" button simultaneously to switch the temperature display between °C and °F.

Replacement of batteries in the remote controller

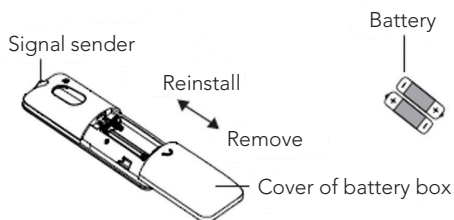

1. Press the backside of the remote controller marked with the , as shown in the figure. Then push out the cover of the battery box in the direction of the arrow.
2. Replace two 7# (AAA 1.5V) dry batteries, and make sure the position of the "+" and "-" poles are correct.
3. Reinstall the cover of the battery box.

Note:

- During operation, point the signal sender of the remote controller at the receiving unit.
- The distance between the signal sender and the receiving unit should be no more than 8 meters, and there should be no obstacles in between.
- The signal of the remote controller may be interfered when there is a fluorescent lamp or wireless telephone in the room. The remote controller should be close to the unit during operation.
- When replacing the batteries is required, use new batteries of the same model.
- If the remote controller is not used for a long time, please take out the batteries.
- If the display on the remote controller is blurry or nothing is displayed at all, please replace the batteries.

CONTROL PANEL

Note: If the remote controller is missing, operate on the control panel.

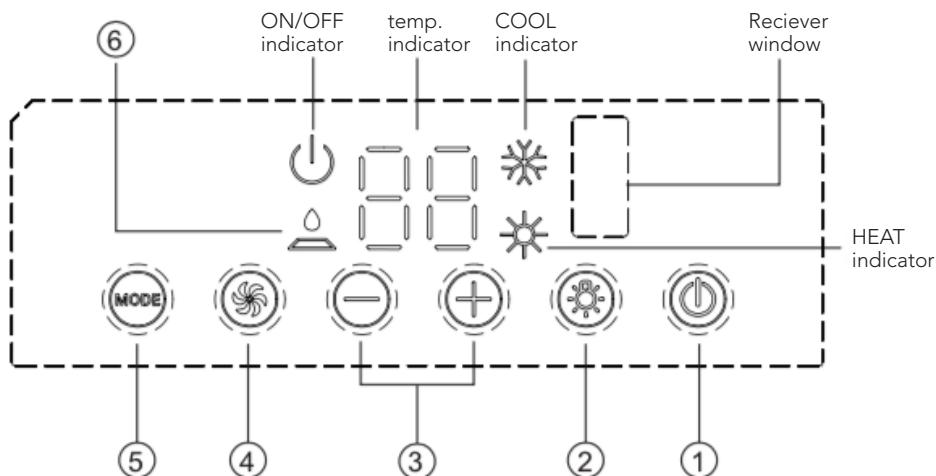

1. **ON/OFF button**
Operation starts when pressing this button, and stops when pressing this button again.
2. **LIGHT button**
Press this button to turn on or turn off display light on indoor unit.
3. **(+/-) button**
Press the + button to increase the set(operating) temperature of the unit, and press the - button to decrease the set(operating) temperature of the unit. the temperature setting range is from 16~30°C (61~86 oF).
4. **FAN SPEED button**
Select the fan speed LOW, MED, HIGH and TURBO in sequence.
5. **MODE button**
Select the operation mode, COOL, FAN, HEAT.
6. **FILTER CHECK indicator**
This feature is a reminder of cleaning the air filter(normal maintenance) for more efficient operation. The light will turn on automatically after the fan works more than 250 hours. If the light is on, turn off and power off the unit, take the air filter out and clean it, then re-install the air filter, power on and turn on the unit, the light will still be on, press + button for 5s, the light will turn off.

INSTALLATION INSTRUCTION

BEFORE INSTALLATION

Testrun the unit with proper power supply. Refer to the operation instruction section in the Owner's Manual Operation & Installation. Make sure all the controls operate correctly then disconnect the power supply of the unit.

WARNING

- Moving parts may cause personal injury. Be careful when test the unit. Do not operate the unit with exterior cover removed.
- The outdoor unit can't be installed in a lower recess of the roof of the vehicle. It must be mounted at a flat surface on the roof to make sure the rain, car-washing water, condensation water etc. can be drained smoothly. Water shouldn't be able to accumulate around the outdoor unit. Otherwise, it will cause malfunction or safety hazards as the water will enter the air conditioner.
- Please use the supplied mounting plate to install the outdoor unit. Otherwise, it may cause malfunction or damage.

STEP 1 – STICKING THE SEALING STRIP AND SPONGE PIECES ON THE OUTDOOR UNIT

1. Before sticking the sealing strip and sponge pieces to the underside of the outdoor unit, clean the sticking areas as shown in figure 1.
2. Take out the sealing strip and the sponge pieces from the packaging, pull off the paper on the glue surface and align them at the sticking positions as shown in Figure 1. If the sealing strip is damaged or not stuck on the proper position, you must replace it with a new one and stick it properly.
3. Check whether the sealing strip and the sponge pieces are tightly adhered, and ensure that they will not fall off.

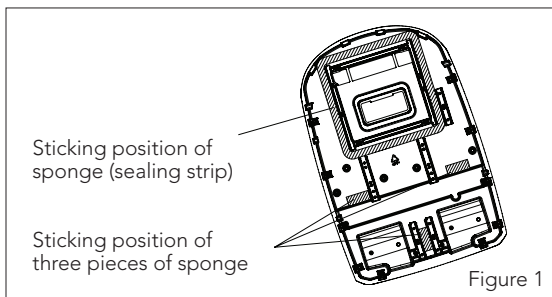

STEP 2-SELECTING AN INSTALLATION LOCATION & INSTALLING THE ROOF TOP AIR CONDITIONER

Your air conditioner has been designed for use in recreational vehicles. Check the roof of the vehicle to determine if it can support both the roof top unit and the ceiling assembly without additional support. Make sure the interior ceiling mounting area will not interfere with existing structures. Once the location for your air conditioner has been determined. A reinforced and framed roof hole opening must be cut (if there is no hole) or you may use existing vent holes.

CASE A.

If a roof vent is already present in the desired mounting location for the air conditioner, the following steps must be performed:

1. Remove all screws which secure the roof vent to the vehicle. Remove the vent and any additional trim. Carefully remove all chalking from around the opening so the surface is clear.
2. It may be necessary to seal some of the old roof vent mounting screw holes which may fall outside of the air conditioner basepan gasket.
3. Examine the roof opening size, if the opening is smaller than 400x400mm, the opening must be enlarged.

CASE B.

If a roof ventilation opening is not used, a new opening must be cut into the roof of the vehicle. A matching opening will also have to be cut into the ceiling inside the vehicle. Be careful as the roof piece can get stuck if the roof is multi-layered. When the opening in the roof and the ceiling are the correct size, a support structure must be fitted between the outside roof and the ceiling inside. The reinforced framework must comply with the following guidelines:

1. It must be capable of supporting both the weight of the roof top air conditioner and the interior ceiling assembly.
2. It must be capable of holding the roof outer surface and interior ceiling apart and supporting them, so that when the roof top air conditioner and ceiling assembly are bolted together, no collapsing occurs. A typical support frame is shown in Figure 1-1.
3. There must be an opening through the frame for the power supply wiring. Route the supply wiring through the frame at the same time the support frame is being installed.

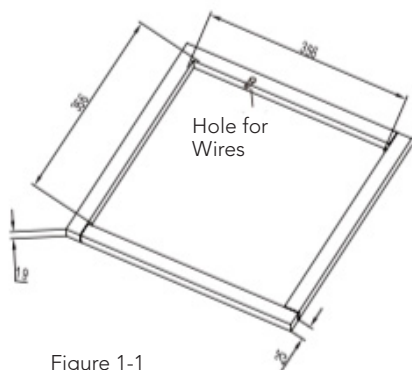

Figure 1-1

INSTALLATION METHOD OF THE MOUNTING PLATE

If the roof of the vehicle already has an 400x400mm opening:

- Choose the installation position for the air conditioner. The mounting adapter is suitable for an opening size of 400×400mm.

Operation method:

- Make sure the installation surface is flat. Remove any obstacles around the opening in the roof.
- Check whether there are holes or grooves on the installation surface. If so, conduct a sealing treatment to prevent water leakage.
- Fill the groove where the mounting adapter is making contact with the roof of the vehicle with unhardened sealant (the maximum thickness is 1cm). When the mounting plate is installed on the top of the vehicle, fill the gap between the mounting plate and the vehicle roof with sealant. The mounting adapter should be sealed tightly together with the roof of the vehicle to prevent water leakage.
- Install it in the opening in the roof of the vehicle according to the direction indicated by the arrow in figure 1-2 (the direction of the arrow should point towards the front of the vehicle).

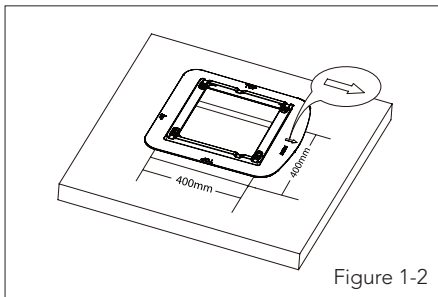
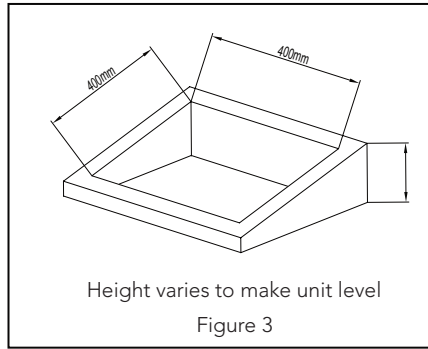
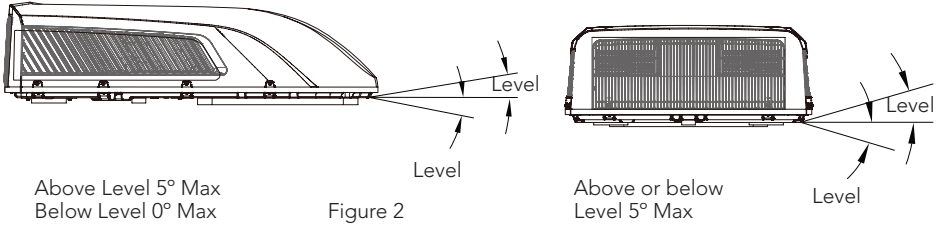

Figure 1-2

CAUTION

1. The roof top air conditioner must be mounted on a level plane from front to rear and side to side when the vehicle is parked on a level plane. Figure 2 shows maximum allowable degrees that the unit can be mounted above or below level.
2. If the roof of the vehicle is sloped (not level) such that the roof top air conditioner cannot be mounted within the maximum allowable degree specifications, an exterior leveling shim will need to be added to make the unit level. A typical leveling shim is shown in Figure 3.
3. Once the roof top air conditioner has been leveled, some additional shimming may be required above the interior ceiling assembly. The roof top air conditioner and the interior ceiling assembly must be square with each other before they are secured together.
4. After the mounting hole area is properly prepared, remove the carton and shipping pads from around the roof top air conditioner. Carefully lift the unit on top of the vehicle. Do not use the outer plastic shroud for lifting. Place the roof top air conditioner over the prepared mounting hole.
5. The point end (nose) of the shroud must face toward the front of the vehicle.

Note: Try your best to put the unit on the horizontal surface for operation. The unit can only operate for a short time at the maximum sloping angle of 5° for preventing water leakage.



NOTE AIR CONDITIONER DIMENSIONS (ROOF OF UNIT)

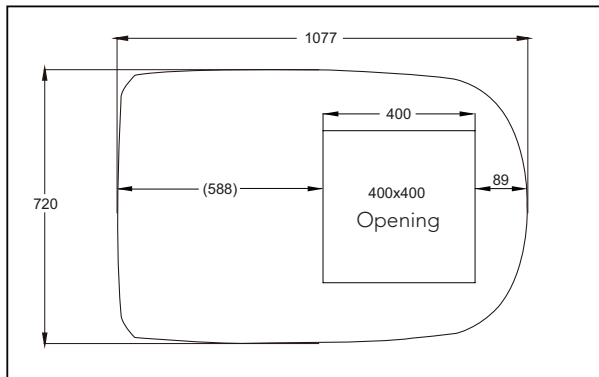

STEP 3-MOUNTING OUTDOOR UNIT

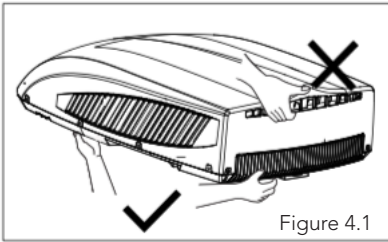

1. Open the package and take out the outdoor unit 1) When taking out the outdoor unit after unpacking, do not lift the air outlet grille at the back of outer case (see Figure4-1).

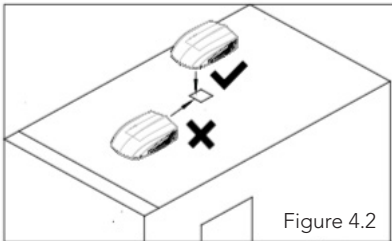

2. Installing the outdoor unit on the mounting adapter:
 - Lift the outdoor unit. It is strictly forbidden to lift the air conditioner by the outer frame.
 - Put it on the mounting adapter on the prepared opening and make sure the sealing strip of the outdoor unit matches with the groove on the surface of the mounting plate. Do not drag the outdoor unit, otherwise the seal may come off.

STEP 4-INSTALLING THE CEILING ASSEMBLY

NOTICE

Make sure that you have properly matched the roof top air conditioner and interior ceiling assembly. Caution before tightening bolts:

1. The applicable thickness of vehicle roof ranges from 30mm~80mm.
2. Before tightening bolts, screw in the four bolts manually and prohibit screwing forcibly.
3. When screwing bolts, you can use automatic tool. Do not tighten one bolt completely and then tighten other bolts, in order to prevent sticking of screw thread. When installing the mounting brackets, the 4 long bolts' screw holes should be aligned with the 4 holes on the adapter. Additionally the mounting brackets should overlap with the surface of the vehicle ceiling. (See Figure 5).

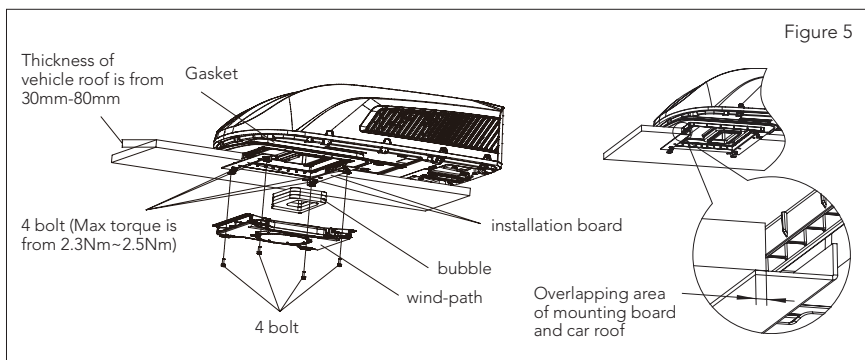

4. The max torque for tightening ranges from 2.3Nm~2.5Nm.

The following step by step instructions must be performed in the following sequence to ensure proper installation.

1. Carefully take the ceiling assembly out of the carton
2. Remove the ceiling grille from the ceiling assembly.
3. Then carry the outdoor unit to the vehicle's top and align with the openings on the vehicle's top. Use 2 sets of mounting plate assembly and 4 screw bolts to mount the outdoor unit (See fig. 5).
4. You must start (thread) themounting bolts by hand to avoid cross-threading. **DO NOT START THE MOUNTING BOLTS WITH AN AIRGUN.** The mounting bolts should be tightened, process is completed when the basepan gasket has been evenly compressed.
5. Before installing the air duct assembly of the indoor unit of recreational vehicle air conditioner, assemble the foam assembly according to the thickness of the vehicle's top. After simulated installation, use an appropriate amount of sponge and foam assembly. Stick the sponge and foam assembly with double faced adhesive tape (prepared by user) (See fig.5-1, 5-2)..
6. Install the foam assembly on the air duct assembly. Use 4 screw bolts to fix the air duct assembly onto the mounting plate. After connecting the outdoor unit with indoor unit, check whether the foam assembly has come loose (See fig.5).

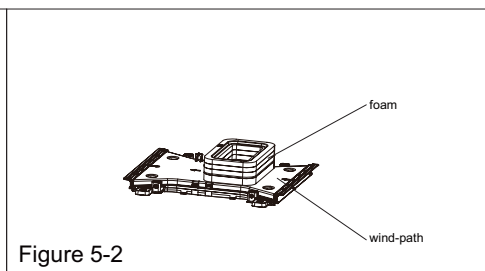
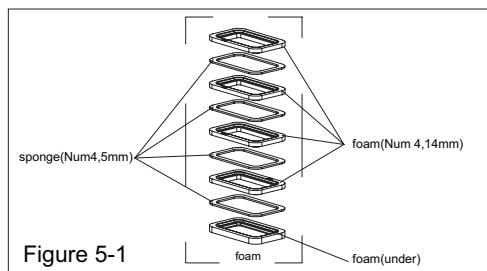
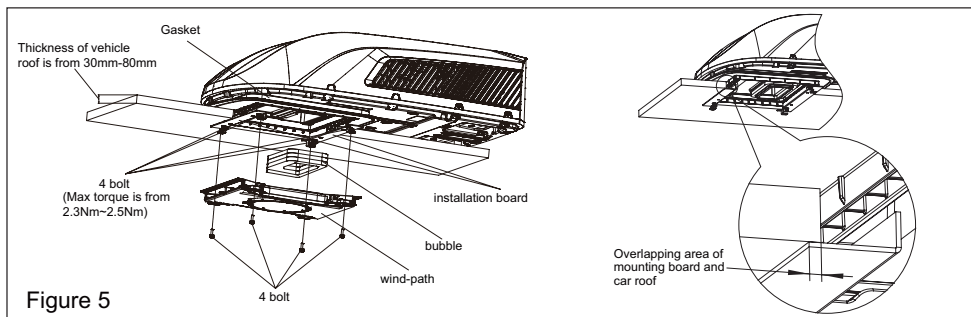

ELECTRICAL WIRING

STEP 5-ELECTRICAL WIRING

ROUTING 220-240V AC WIRING

WARNING : Make sure that all power supply to the unit is disconnected before performing any work on the unit to avoid the possibility of shock or injury and/or damage to the equipment. After the interior ceiling assembly frame is properly secured to the roof top air conditioner, the following electrical connections must be performed.

1. As shown in fig.6, the outdoor unit has two sets of outgoing wires, which are power cord (high current) and the control signal wires respectively. The former one should be directly connected to the power supply terminal while the latter one should be connected to the control signal wire of the indoor unit.
2. As shown in fig.7, the indoor unit has one set of control signal wires, with 4 wiring terminals in total.
3. As shown in fig.8, connect the wiring terminals of indoor and outdoor units one by one. Then use a piece of sponge to wrap the wiring terminals together, with each terminal separately encircled by the sponge. Avoid gaps between each wire.

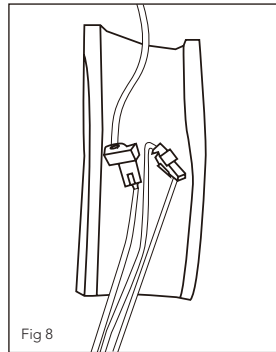
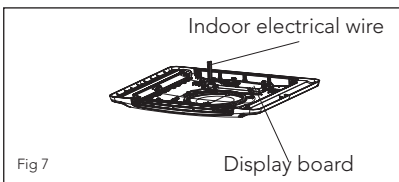
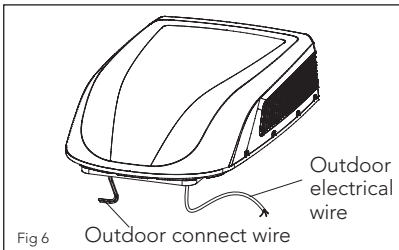

4. shown in the picture, use a piece of thermal insulating jacket to enclose the wiring terminals and sponge. Then glue the thermal insulating jacket and fasten it with cable ties.

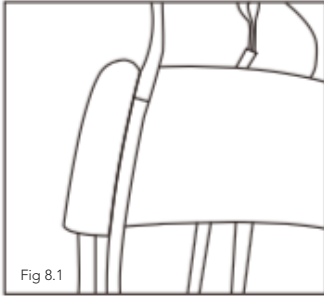

Fig 8.1

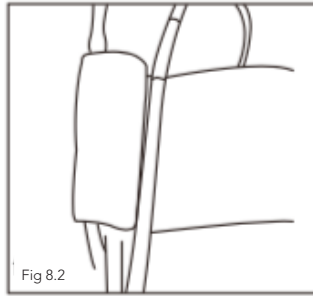

Fig 8.2

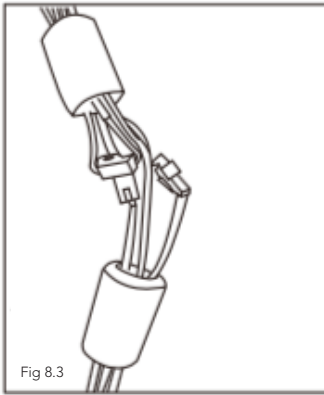

Fig 8.3

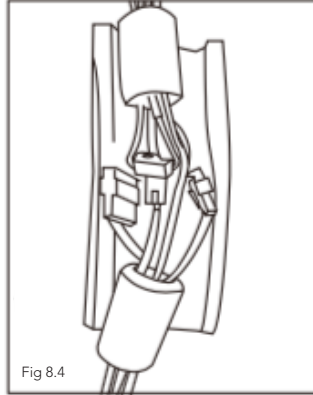

Fig 8.4

NOTE

1. Cable ties must be attached to the area with both sponge and thermal insulating jacket;
2. Before installing the front panel of indoor unit, put the thermal insulating jacket on top of the air duct.

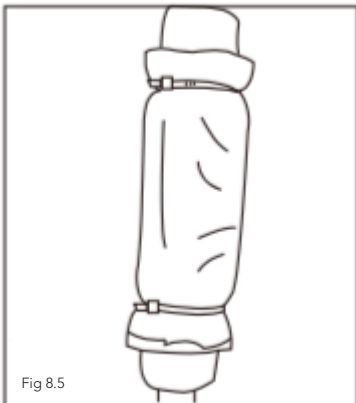

Fig 8.5

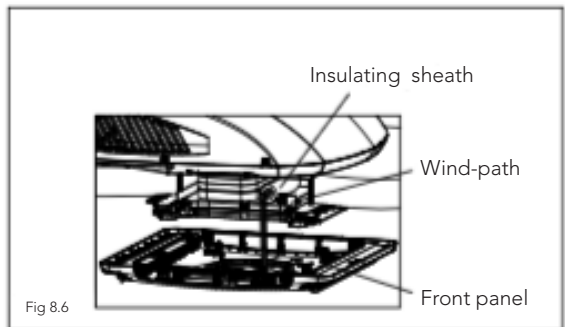

Fig 8.6

COMPLETING THE INSTALLATION

STEP 6-COMPLETING THE INSTALLATION

To complete the installation and system checkout requirements, the following steps must be performed.

1. Check the thermostat position. Make sure the thermostat is routed through the holding guide and is not touching any metal surface.
2. Secure the ceiling grille to the ceiling assembly wind-path with 4 screws. (see Figure 9).
3. Install the healthy filter and air intake grill. Press "PUSH" and lock with clasps.
4. Switch on the power supply and check the unit work or not.
5. Once the indoor unit is assembled, if the gap between the panel and the top of vehicle is not even, please ask the manufacturer to adjust it according to the assembly status.

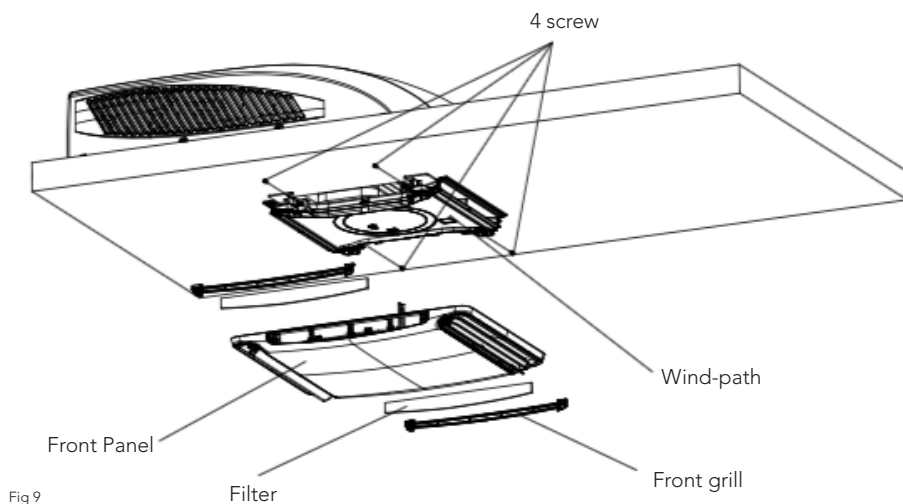

TROUBLESHOOTING

TROUBLESHOOTING GUIDE

If you have problems with your recreational vehicle air conditioner, check this guide before contacting your service representative.

TROUBLE	POSSIBLE CAUSE	SOLUTION
The unit can not start	The unit may not be connected to the power supply correctly.	Check the power supply of the vehicle and make sure it is provided correctly.
The unit can not cool the room	The roof top air conditioner is not level.	Mount the roof top air conditioner as level as possible from front to rear and side to side when the vehicle is parked. Make sure that the mounting of the air conditioner is correct and level.
	The temperature setting is too high.	Reset the remote control to a lower temperature setting.
	The air filter is dirty.	Remove and clean the filter.
	The room was already very hot before the unit was turned on.	Allow a sufficient amount of time for the unit to cool the room.
The unit is making noise	The unit is click and gurgle.	These noises are normal during the operation of the unit.
The unit has water dripping inside	The basepan gasket had not been evenly compressed.	Mounting bolts should be tightened evenly by compressing the basepan gasket.
The unit has ice or frost on the coils	The temperature is low inside.	Select FAN mode at HIGH fan speed.
	The filter is dirty.	Remove and clean the filter.

ERROR CODE

When air conditioner status is abnormal, temperature indicator on indoor unit will blink to display corresponding error code. Please refer to below list for identification of error code.



Indoor display

Above indicator diagram is only for reference. Please refer to actual product for the actual indicator and position.

Error code

ERROR CODE	TROUBLESHOOTING
E6/E8	It can be eliminated after restarting the unit. If not, please contact qualified professionals for service.
PL	The power supply voltage is too low. Please check whether the voltage is correct. It can be eliminated after restarting the unit. If not, please contact qualified professionals for service.
F1/F2/F3/F4	Please contact qualified professionals for service.

Note: If there're other error codes, please contact qualified professionals for service.

NORMAL MAINTENANCE PROCEDURES

ACTIVITY	FREQUENCY
Remove the cover and wash the condenser coil	Twice a year.
Clean the filter (More frequent cleaning may be necessary depending on the air quality)	When the air conditioner FILTER CHECK light is on.

HOW TO REMOVE THE AIR FILTER

Push both sides of the air intake grill on the positions marked with "PUSH". Open the air intake grill and then take out the healthy filter.



HOW TO CLEAN THE AIR FILTER

Wash away dust from the air filters with clean water or vacuum the filter with an electric household vacuum cleaner.

WARNING

FAILURE TO FOLLOWING INSTRUCTIONS COULD RESULT IN SERIOUS PERSONAL INJURY

1. Don't touch the capacitor terminals without the electric discharge, the capacitor still may have the high voltage even though the power supply is turned off.
2. Be careful when you maintain the refrigeration system, which has the high internal pressure.
3. Do not block the filter and the indoor air inlet badly to prevent water leakage.



RECYCLING

This product bears the selective sorting symbol for waste electrical and electronic equipment. This means that this product must be handled pursuant to European Directive (2012/19/EU) in order to be recycled or dismantled to minimize its impact on the environment. For further information, please contact your local or regional authorities. Electronic products not included in the selective sorting process are potentially dangerous for the environment and human health due to the presence of hazardous substances.

DECLARATION OF CONFORMITY

Hereby Gimeg Nederland B.V. declares that the device RTA-2600, applies all basic requirements and other relevant regulations listed in the European directive for electromagnetic compatibility (2014/30/EU) and low voltage directive (2014/35/EU). If you require a full declaration of conformity, you can contact the address listed on the backside of this manual

mestic®

Importer:
Gimeg Nederland B.V.
Strijkviertel 27
3454 PH De Meern
The Netherlands